



For more details  
scan this QR code.

67869A 03/22 (MTE)



## MCD3-1999 User Manual

\*\* Please be advised that certain images within these instructions depict the European model.  
All units supplied in Australia are fully compliant with Australian Standards.

[WWW.OJELECTRONICS.COM](http://WWW.OJELECTRONICS.COM)

© 2022 OJ Electronics A/S

# Table of contents

Table of contents . . . . .	2	Adaptive start (RdAP) . . . . .	17
Introduction . . . . .	3	Adjust (RdJ) . . . . .	18
Menu overview . . . . .	4	Software version (-5U) . . . . .	19
Icons . . . . .	5	Temperature readout (-FEP, -rEP) . . . . .	20
Buttons and navigation . . . . .	6	Power limit (PL i) 1/2 . . . . .	21
Adjust the heating schedule . . . . .	7	Power limit (PL i) 2/2 . . . . .	22
Override the heating schedule . . . . .	8	Pulse width modulation (PULS) 1/2 . . . . .	23
Child Lock . . . . .	9	Pulse width modulation (PULS) 2/2 . . . . .	24
Factory reset . . . . .	10	Floor temperature limits (FLLo, FLHi) . . . . .	25
Time settings (cLc) . . . . .	11	Temperature limits (ELLo, ELHi) . . . . .	26
Day settings (dRd) . . . . .	12	Sensor application (APP) . . . . .	27
Schedule and events (ScHE) . . . . .	13	Exiting the menu (dOnE) . . . . .	28
Display settings (Lcd) . . . . .	14	Change of front cover . . . . .	29
Remote Control (rCE) . . . . .	15	Troubleshooting and additional information . . . . .	30
Open Window (OPeN) . . . . .	16		



# Introduction

---

Thank you for buying our MCD3 thermostat. We hope you will enjoy the ease of use offered by the well-known user interface and design. This high-quality thermostat has a minimum impact on the environment by design and will at the same time provide you with long-lasting heating comfort.

The thermostat switches on your floor heating at preset times each day of the week. The thermostat is preset with up to four events for each day of the week. Lowering the temperature when your home is unoccupied reduces your energy costs without reducing comfort. The thermostat comes with preset heating schedules adjustable to your specific needs.

A temperature setting range from 0°C to 40°C and an external override function ensures your comfort and protects your property.

This thermostat can be used as a controller for electric room heating pursuant to EN50559.

For enquiries, please contact Coldbuster Floor Heating.  
Call: **1800 85 75 65**  
Text: **0488 855 826**  
[support@coldbuster.com.au](mailto:support@coldbuster.com.au)  
[www.coldbuster.com.au](http://www.coldbuster.com.au)



For more details  
scan this QR code.

# Menu overview

Settings	Options
cLc (Clock)	00:00 - 23:59
dRY (Day)	Mon, TuE, WEd, tHu, Fri, SAT, Sun
SchE (Schedule)	5-2, 6-1, 1E2, 1E4, 7E4
Lcd 1 (Lcd)	Set, cLc, --
Lcd2 (Lcd)	Set, tP
rCt (Remote controlled temp.)	5..25°C
OPEN (Open window)	On/Off
RdRP (Adaptive start)	On/Off
RdJ (Adjust)	-9.9..10°C
-Su (Software Version)	Readout value
-FLP (Floor temp.)	Readout value
-rLP (Room temp.)	Readout value
PL (Power Limit)	0..30

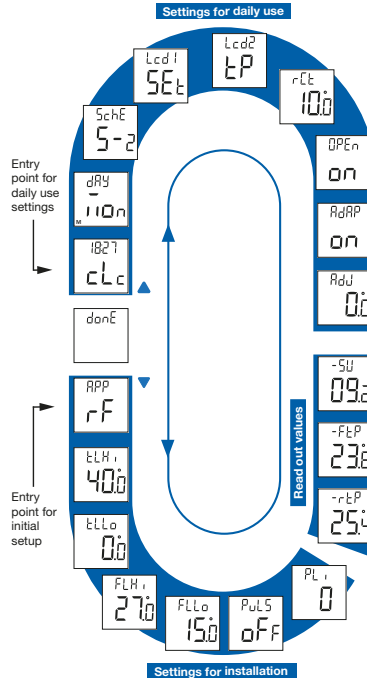







Settings	Options	
PuLS (Pulse Width Modulation)	Aut	CYHi: 10..60 CYLo: 10..30
	Off	DIFF: 0.3..10°C
	On	CYcL: 10..60
FLLo (Floor limit low)	0..40°C	
FLH (Floor limit high)	0..40°C	
tLl (Temp. limit low)	0..40°C	
tLH (Temp. limit high)	0..40°C	
APP (sensor application)	r	Room
	F	Floor
	C	Regulator
	rF	Room w. floor limits
	rE	External room sensor
donE (Done)		



# Icons

---

Icon	Meaning	Icon	Meaning
	Schedule operation		Manual mode
REMOTE	Remote Control		Temperature scale, Celsius
	Open window		The thermostat is in regulator mode APP: C
	Heating is activated	SET	Setpoint
	Child lock is engaged		



# Buttons and navigation

---



## Buttons and navigation

The front cover can be flipped down.

The on/off switch is located behind the front cover, on the left side of the front, up = on / down = off.

On the right there are three buttons: A top button "▲", a middle button "■" and a bottom button "▼".

"■": The middle button is used to access the menu and confirm changes and settings made in the menu.

"▲" and "▼": The up and down buttons are used to navigate through the menu and change parameters and settings.



# Adjust the heating schedule



You can adjust the preset schedule to your own needs, by adjusting the time and setpoint temperature. To change the heating schedule, see page 13.

## Changing the time and setpoint in an event:

- Press "▲" and "▼" for 3 seconds to enter schedule and event settings.
- You can now change the time and temperature setpoint for event 1 in the chosen schedule.
- Use "▲" and "▼" to change the time and confirm with "■".
- Use "▲" and "▼" to change the temperature setpoint and return with "■".

*Note: Step 3 and 4 will be repeated either 2 or 4 times for each day, depending on the number of events in the chosen schedule (see previous page)*

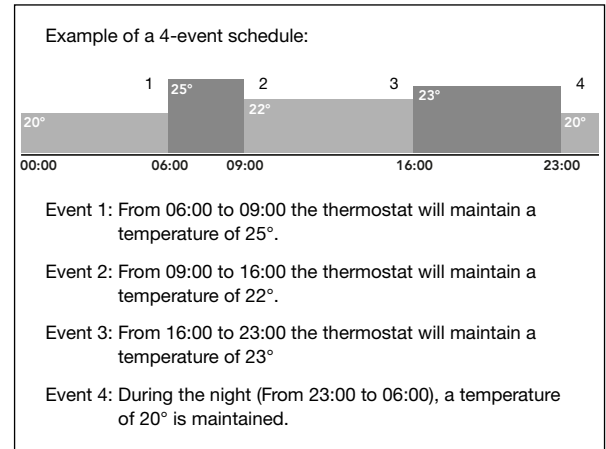

## Menu structure:

SchE: 5-2, 6-1, 1E4, 7E4, 1E2



# Override the heating schedule



## Override heating schedule

**Temporary override:** During scheduled operation, you can either use "▲" or "▼" to override the programmed setpoint/temperature. This override will hold until next scheduled event.

During temporary override, a clock "🕒" and manual mode "👉" symbol are shown on the display.

**Permanet override:** Press the "■" one time to activate manual override. The thermostat is now in manual operation and the setpoint temperature can be adjusted with "▲" or "▼".

Press "■" again to exit manual mode and continue with scheduled operation. During manual mode override, the manual mode symbol "👉" is shown on the display.



# Child Lock



## Child Lock

The child lock can be activated directly if the thermostat is idle, or if the thermostat's backlight is activated, but never from within the menu.

- Activate the child lock by pressing "▲" and "▼" simultaneously for 8 seconds, until the padlock "🔒" icon is shown on the display.
- The padlock icon indicates that the childlock is activated.
- Deactivate the child lock by pressing "▲" and "▼" simultaneously for 8 seconds, until the padlock icon is no longer shown in the display.



# Factory reset



## Factory reset

- Activate the thermostat by pressing any of the three buttons. The backlight will be lit.
- Press "■" for 8 seconds until the factory reset menu appears.

**Note:** After 3 seconds the thermostat will enter the settings - Keep pressing "■" for additional 5 seconds.

- Use "▲" or "▼" to navigate through the options and confirm with "■".
  - no: The thermostat will not perform a factory reset.
  - SchE: The thermostat will return all schedule and event settings to default.
  - ALL: All settings in the thermostat will be factory reset.



# Time settings (⌂⌂)



This option allows you to set the time. The time settings is used to control the event during scheduled operation.

## Access clock settings:

- Press "■" for 3 seconds to enter the settings.
- Scroll through the settings until ⌂⌂ appears on the display.
- Press "■" to enter the options.
- Use "▲" or "▼" to change hours. Return with "■".
- Use "▲" or "▼" to change minutes. Return with "■".

## Menu structure:

⌂⌂: 00:00 to 23:59



# Day settings (dAY)



This option allows you to change the day of the week. This is used by the heating schedule during scheduled operation.

## Access day settings:

- Press "■" for 3 seconds to enter the settings.
- Scroll through the settings until dAY appears on the display.
- Press "■" to enter the options.
- Use "▲" or "▼" to change the day of the week.

## Menu structure:

dAY: Mon, TuE, WEd, Thu, Fr i, SAT, Sun



# Schedule and events (SCHE)



This option allows you to choose the schedule that best fits your needs. you can also turn it off.  
To adjust a preset schedule, see page 7.

The schedules differ in the number of days with 4 events and 2 events.

## Definition of different schedule types:

- 0FF: Events are disabled and the setpoint temperature is maintained 24/7
- 5-2: Monday to Friday with 4 events, Saturday and Sunday with 2 events
- 6-1: Monday to Saturday with 4 events, Sunday with 2 events
- 1E4: Monday to Sunday with 4 events
- 7E4: Monday to Sunday are individual, with 4 events
- 1E2: Monday to Sunday with 2 events

## Access schedule and event settings:

- Press "■" for 3 seconds to enter the settings.
- Scroll through the settings until SCHE appears on the display.
- Press "■" to enter the options.
- Use "▲" or "▼" to change the schedule.
- Press "■" to return to the settings.



# Display settings (Lcd)

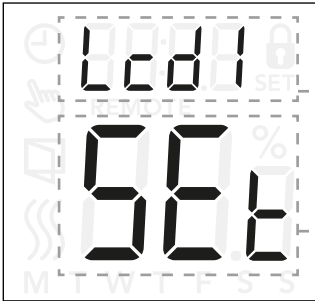

This setting allows you to select which data you want to be shown in the idle display.

Lcd 1:

Set = Temperature setpoint

cLc = Clock

-- = Nothing is shown.

Lcd 2:

Set = Temperature setpoint

tP = Measured temperature

Display settings are not applicable if the sensor application is set to **C**.

## Access display settings:

- Press "■" for 3 seconds to enter the settings.
- Scroll through the settings until either Lcd 1 or Lcd 2 appears on the display.
- Press "■" to enter either Lcd 1 or Lcd 2.
- Use "▲" or "▼" to select what data you want to see on Lcd 1 or Lcd 2.
- Press "■" to return to the settings.

## Menu structure:

Lcd 1:

SEt: Temperature setpoint

cLc: Clock

--: Nothing is shown.

Lcd 2:

SEt: Temperature setpoint

tP: Measured temperature



# Remote Control (r [E])



This setting allows you to set the temperature setpoint for the thermostat, when it is remote controlled.

Remote control is activated from a 230V signal possibly through an external control, clock or timer, connected to the S-terminal.

When the thermostat is remote controlled “REMOTE” is shown in the display.

This setting is factory set to 10°C but can be set between 5 and 25°C in steps of 0.5°C.

## Access remote controlled temperature settings:

- Press “■” for 3 seconds to enter the settings.
- Scroll through the settings until r [E] appears on the display.
- Press “■” to enter the options.
- Use “▲” or “▼” to set the temperature between 5 and 25°C. Return with “■”.

## Menu structure:

r [E]: 5 and 25°C



# Open Window (OPEN)



This setting allows you to enable the "Open window" function.

The thermostat can detect an open window by registering a rapid drop in temperature.

With the function enabled, the thermostat stops heating for 30 minutes if an open window is detected.

## Access settings for open window function:

- Press "■" for 3 seconds to enter the settings.
- Scroll through the settings until OPEN appears on the display.
- Press "■" to enter the options.
- Use "▲" or "▼" set the open window function On or Off.

## Menu structure:

OPEN:

On: Open window function is enabled.

Off: Open window function is disabled.



# Adaptive start (AdAP)



## Access settings for adaptive start:

- Press "■" for 3 seconds to enter the settings.
- Scroll through the settings until AdAP appears on the display.
- Press "■" to enter the options.
- Use "▲" or "▼" set the open window function On or Off.

This setting allows you to enable adaptive start function. After a few days, the adaptive start will have automatically calculated how much earlier the heating must be turned on/off to achieve this.

See illustrations below when adaptive start is ON or OFF:

Adaptive start On:

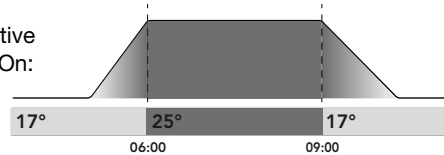

Adaptive start Off:

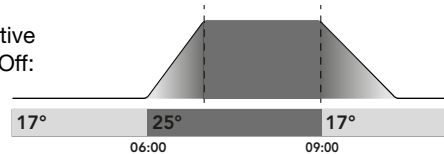

## Menu structure:

AdAP:

On: Adaptive start is enabled.

Off: Adaptive start is disabled.



# Adjust (Adj)



This option allows you to calibrate the measured room temperature.

You should only calibrate the sensor if the temperature reading differs significantly from the actual temperature.

**Note** that with sensor application **F**, the temperature is measured in the floor, this temperature would be higher than the ambient temperature.

Adjust is not applicable if the sensor application is set to **C**.

## Access adjustment settings:

- Press "■" for 3 seconds to enter the settings.
- Scroll through the settings until either Adj appears on the display.
- Press "■" to enter Adjustment options.
- Use "▲" or "▼" to adjust the temperature.
- Return to the settings with "■".

## Menu structure:

Adj: Measured temperature -9,9...10°C



# Software version (-5U)

---

This setting provides a read-out of the software version.



## Accessing software version readout:

- Press "■" for 3 seconds to enter the settings.
- Scroll through the settings until -5U appear on the display. The SW version is shown below.

## Menu structure:

-5U: Read-out



# Temperature readout (-FŁP, -rŁP)



Depending on the type of sensor and sensor application setting, the temperature from the floor sensor (-FŁP) and the internal room sensor (-rŁP) can be monitored here.

Temperature readout are not applicable if the sensor application is set to **C**.

## Access temperature read-out:

- Press "■" for 3 seconds to enter the settings.
- Scroll through the settings until either -FŁP (Floor temperature) or -rŁP (Room temperature) appears on the display.

## Menu structure:

- FŁP: Readout of the actual measured floor temperature
- rŁP: Readout of the actual measured room temperature.



# Power limit (PL $\downarrow$ ) 1/2



This thermostat complies with EN 50559 for electrical floor heating. The regulation applies to electrical floor heating with a maximum floor weight of 4 kN/m<sup>2</sup>. To ensure that hotspots due to unintentionally covering up the surface are avoided, the heating function can be time-limited as per EN/DIN.

The heating can be limited by a set number of minutes per hour. The thermostat will then divide the given number of minutes per hour into 3 periods, depending on the thermostat's actual PWM cycle.

*Note that this function is not applicable to other heating applications such as wall and/or ceiling heating if it can be foreseen that unintentional covering up of floor area might occur. In this case it would be important to assess the correct period of time for which the floor heating must be time-limited.*

Example:

If obstacles could be present that cover up the floor, then the heating might need to be limited by a number of minutes so as to avoid hotspots on the floor.

If you want the thermostat to provide heat a maximum of 90% of the time, then the thermostat should be limited by 10%. Ten percent of one hour is 6 minutes.

## Access power limit settings:

- Press "■" for 3 seconds to enter the settings.
- Scroll through the settings until PL  $\downarrow$  appears on the display.
- Press "■" to enter the options.
- Use "▲" or "▼" to change the power limit.
- Return to the settings with "■".



# Power limit (PL i) 2/2



Enter 6 minutes in the power limit menu in order to reduce the heating by 10%.

Equation to calculate number of minutes that could be entered in the power limit menu - when an average heating effect is desired:

$$\left( 1 - \left( \frac{\text{Average desired heating effect per } m^2}{\text{Floor heating element output per } m^2} \right) \right) * 60 \text{ min.}$$

*Note:*

*If the result of the equation is negative then nothing should be entered.*

The function is factory set to 0 minutes but can be set to values between 0-30 minutes in steps of 1 minute.

**Menu structure:**

PL i: 0...30min



# Pulse width modulation (PULS) 1/2



With this setting, you can change the duration of the heating periods.

**Off:** Simple “on/off” regulation, where the relay is on when the measured temperature is below the setpoint and off when the measured temperature is above the setpoint. A hysteresis ( $d_{iFF}$ ) is used to avoid too frequent relay switching.

**On:** The relay is off or on depending on the average temperature measured in a fixed period of time (10...60 minutes). Depending on the temperature deviation, the duty cycle of the “on time” is increased or decreased, giving longer or shorter time periods when the heating is active.

## Access Pulse Width Modulation (PWM) settings:

- Press “■” for 3 seconds to enter the settings.
- Scroll through the settings until PULS appears on the display.
- Press “■” to enter the options.
- Use “▲” or “▼” to change the regulation type.
- Choose either PULS, OFF or ON. See page 24 and 25 for further information of the regulation types.
- Return to the settings with “■”.



# Pulse width modulation (PULS) 2/2



**Auto:** Similar to “PWM On”, but the PWM period is increased or decreased depending on the minimum and maximum temperature measured during a PWM period. This will increase the lifetime of the relay by reducing the number of relay switches, and still ensure the comfort of the user by keeping temperature fluctuations below an acceptable level.

## Menu structure:

PULS:

    RuL: CYHi: 10...60min

        CYLo: 10...30min

    oFF: DiFF: 0.3...10°C

        oOn: CYcL: 10...60min



# Floor temperature limits (FLL<sub>l</sub>, FLH<sub>h</sub>)

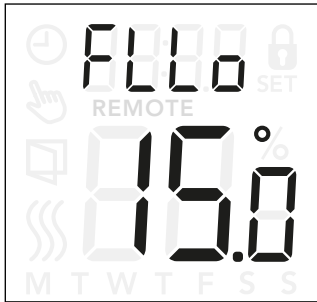

These settings allow you to set the minimum and maximum limits for the floor temperature, for example to protect sensitive floors..

## Floor temperature limits:

Floor temperature limits allow you to set the highest (FLH<sub>h</sub>) and lowest (FLL<sub>l</sub>) permissible floor temperature during room temperature control with the sensor application **rF**.

If the floor temperature rises above the maximum temperature limit, the thermostat will deactivate the heating system to protect sensitive floor types. If the floor temperature drops below the minimum temperature limit, the thermostat will activate the heating system to maintain the temperature above the set minimum.

*Note: that this feature is only applicable in sensor application **rF**.*

## Menu structure:

FLH<sub>h</sub>: 0...40°C

FLL<sub>l</sub>: 0...40°C

## Access the Floor Limit settings:

- Press "■" for 3 seconds to enter the settings.
- Scroll through the settings until either FLL<sub>l</sub> (Floor limit low) or FLH<sub>h</sub> (Floor limit high) appears on the display.
- Press "■" to enter FLL<sub>l</sub> or FLH<sub>h</sub>.
- Use "▲" or "▼" to adjust the temperature limits.
- Return to the settings with "■".



# Temperature limits (ELL◻, ELH ◻)



These settings allow you to set the minimum and maximum temperature that the thermostat can operate inbetween.

## Operating temperatures:

Temperature limit low (ELL◻) can be used to secure that the temperature setpoint is unable to be set below a specific value. Can be set between 0 and 40°C.

Temperature limit high (ELH ◻) can be used to secure that the temperature setpoint is unable to be set above a specific value. Can be set between 0 and 40°C.

*Note: If the maximum temperature limit is set too high, sensitive floor types may be permanently damaged.*

## Access the temperature limit settings:

- Press "■" for 3 seconds to enter the settings.
- Scroll through the settings until either ELL◻ (temperature limit low) or ELH ◻ (temperature limit high) appears on the display.
- Press "■" to enter either ELL◻ or ELH ◻.
- Use "▲" or "▼" to adjust the temperature limits.
- Return to the settings with "■".

## Menu structure:

ELL◻: 0...40°C

ELH ◻: 0...40°C



# Sensor application (APP)



## Access sensor application:

- Press "■" for 3 seconds to enter the settings.
- Scroll through the settings until APP appears on the display.
- Press "■" to enter the sensor application setting.
- Use "▲" or "▼" to select the application that fits your installation.
- Return to the settings with "■".

This option allows you to choose which sensor is used to control the heating system.

- **r**: The internal room sensor inside the thermostat, controls the heating system.
- **rE**: An external room sensor (connected to the floor sensor terminals) controls the heating system.
- **rF**: The internal room sensor controls the heating system subject to maximum and minimum limits for floor temperature. The maximum temperature limit protects wooden floors from excessive heat. The minimum temperature limit prevents the floor from becoming uncomfortably cold when heating is not needed, such as in a bathroom. Note that this function will increase energy consumption. Floor limit temperatures are set in the "FLLo, FLHi" settings. (see page 26)
- **c**: The thermostat operates as a regulator and no sensors are used. Note that floor protection is not active when using this application.
- **F**: The external floor sensor controls the heating system

## Menu structure:

APP: r; rE; rF; C; F



# Exiting the menu (done)



All changes in the settings are saved once the menu is exited.

The settings can be exited either by using the "done" option, or if no buttons pressed for 30 seconds.

## Exiting the menu:

- Press "■" for 3 seconds to enter the settings.
- Scroll through the settings until done appear on the display.
- Press "■" to exit the menu and return to the main screen.

## Menu structure:

done: Return to main screen



# Change of front cover

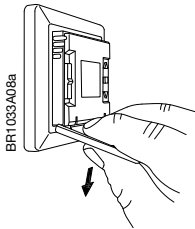

1. Open the front cover
2. Hold the front cover with the index, middle and ring finger on the top side of the front cover as close as possible to the thermostat.
3. Pull the front cover downwards.

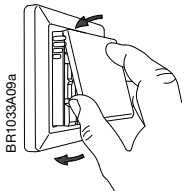

4. Align the top of the new front cover with the top of the thermostat.

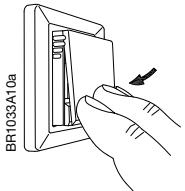

5. Press at the bottom of the new front cover to close.



# Troubleshooting and additional information

---

## Error codes

E0 (C - 5E): **Internal Compensation Sensor error.**  
Heating is shut off.

E1 (I - 5E): **Internal Sensor Error.**  
The sensor application is changed to **C** (regulator).

E2 (E - 5E): **External Sensor Error.**  
(The sensor is either damaged, has shorted or disconnected).  
The sensor application is changed to **C** (regulator)  
If **rF** is used - the sensor application is changed to **r**  
(internal room sensor).

E5 (I - OH): **Internal OverHeat**  
Internal overheating. If the E5 error persists, please contact your installer.

*Note that the backlight is lit if any fault is detected.*

## Support

For support, please contact your installer or place of purchase.

For enquiries, please contact Coldbuster Floor Heating.  
Call: **1800 85 75 65**  
[support@coldbuster.com.au](mailto:support@coldbuster.com.au)  
[www.coldbuster.com.au](http://www.coldbuster.com.au)

**COLDBUSTER**<sup>®</sup>  
*floorheating*  
Affordable Luxury<sup>™</sup>



For more details  
scan this QR code.